

DAEWOO

edition-1

MICROWAVE OVEN

KOR-616T

OPERATING
INSTRUCTIONS

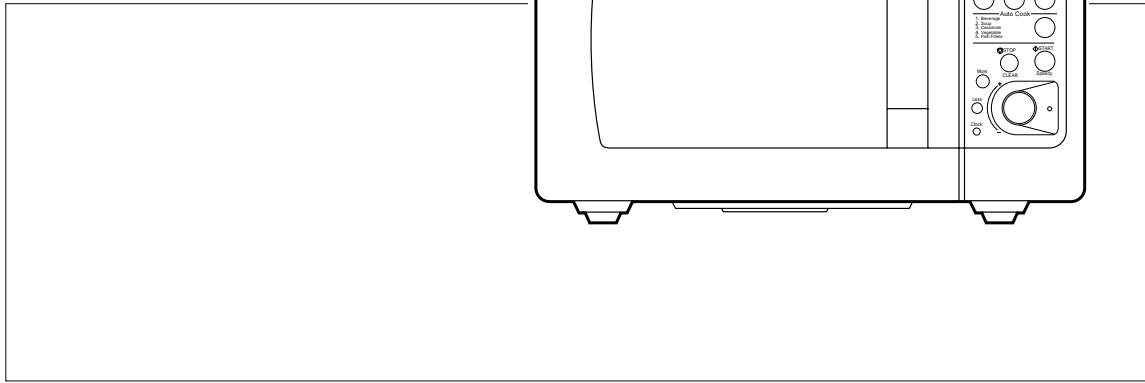

Before operating this oven, please read these instructions completely.

PRECAUTIONS TO AVOID POSSIBLE EXPOSURE TO EXCESSIVE MICROWAVE ENERGY

- (a) **Do not attempt to operate this oven with the door open** since open-door operation can result in harmful exposure to microwave energy. It is important not to defeat or tamper with the safety interlocks.
- (b) **Do not place any object** between the oven front face and the door or allow soil or cleaner residue to accumulate on sealing surfaces.
- (c) **Do not operate the oven** if it is damaged. It is particularly important that the oven door close properly and that there is no damage to the: (1) door (bent), (2) hinges and latches (broken or loosened), (3) door seals and sealing surfaces.
- (d) **The oven should not be adjusted or repaired** by anyone except properly qualified service personnel.

TABLE OF CONTENTS

PRECAUTIONS TO AVOID POSSIBLE EXPOSURE TO EXCESSIVE MICROWAVE ENERGY	1
TABLE OF CONTENTS	1
IMPORTANT SAFETY INSTRUCTIONS	2
FEDERAL COMMUNICATIONS COMMISSION RADIO FREQUENCY INTERFERENCE STATEMENT (U.S.A ONLY)	3
GROUNDING INSTRUCTIONS	3
INSTALLATION	4
SPECIFICATIONS	5
FEATURES DIAGRAM	6
CONTROL PANEL	7
HOW TO SET THE OVEN CONTROLS	8
CLOCK	8
TIME DEFROST	9
WEIGHT DEFROST	10
COOKING IN ONE STAGE	11
COOKING IN TWO STAGES	12
AUTO COOK	14
SPEEDY COOK	16
CHILD SAFETY LOCK	16
TO STOP THE OVEN WHILE IT IS OPERATING	17
GENERAL GUIDELINES	18
COOKING UTENSILS	19
CARE AND CLEANING	19
BEFORE CALLING FOR SERVICE	20
QUESTIONS AND ANSWERS	21

IMPORTANT SAFETY INSTRUCTIONS

When using electrical appliances basic safety precautions should be followed, including the following:

WARNING - To reduce the risk of burns, electric shock, fire, injury to persons or exposure to excessive microwave energy:

- 1 Read all instructions before using the appliance.
- 2 Read and follow the specific "**PRECAUTIONS TO AVOID POSSIBLE EXPOSURE TO EXCESSIVE MICROWAVE ENERGY**" found on page 1.
- 3 This appliance must be grounded. Connect only to properly grounded outlet. See "**GROUNDING INSTRUCTIONS**" found on page 3.
- 4 Install or locate this appliance only in accordance with the provided installation instructions.
- 5 Some products such as whole eggs and sealed containers for example, closed glass jars-may explode and should not be heated in this oven.
- 6 Use this appliance only for its intended use as described in this manual. Do not use corrosive chemicals or vapors in this appliance. This type of oven is specifically designed to heat, cook, or dry food. It is not designed for industrial or laboratory use.
- 7 As with any appliance, close supervision is necessary when used by children.
- 8 Do not operate this appliance if it has a damaged cord or plug, if it is not working properly, or if it has been damaged or dropped.
- 9 This appliance should be serviced only by qualified service personnel. Contact the nearest authorized service facility for examination, repair or adjustment.
- 10 Do not cover or block any openings on the appliance.
- 11 Do not store this appliance outdoors. Do not use this product near water-for example, near a kitchen sink, in a wet basement or near a swimming pool, and the like.
- 12 Do not immerse cord or plug in water.
- 13 Keep cord away from heated surfaces.
- 14 Do not let cord hang over edge of table or counter.
- 15 Either-(a) When cleaning surfaces of door and oven that comes together on closing the door, use only mild, nonabrasive soaps or detergents applied with a sponge or soft cloth; or when separate cleaning instructions provide, (b) See door surface cleaning instructions on (specific page or sections to be included).
- 16 To reduce the risk of fire in the oven cavity:
 - (a) Do not overcook food. Carefully attend appliance if paper, plastic, or other combustible materials are placed inside the oven to facilitate cooking.
 - (b) Remove wire twist-ties from paper or plastic bags before placing bag in oven.
 - (c) If materials inside the oven should ignite, keep oven door closed, turn oven off, and disconnect the power cord, or shut off power at the fuse or circuit breaker panel.
 - (d) Do not use the cavity for storage purposes. Do not leave paper products, cooking utensils, or food in the cavity when not in use.
- 17 Do not use this microwave oven to heat corrosive chemicals (for example, sulfides and chlorides). Vapors from such corrosive chemicals may interact with the contact and springs of the safety interlock switches thereby rendering them inoperable.
- 18 Do not place anything on top of this oven.

CAUTION: Always set short cooking times and check the food frequently. If the recommended cooking times are exceeded the food, especially oil or fat, will be spoiled and in extreme circumstances could catch fire.

SAVE THESE INSTRUCTIONS

FEDERAL COMMUNICATIONS COMMISSION RADIO FREQUENCY INTERFERENCE STATEMENT (U.S.A ONLY)

WARNING:

This equipment generates and uses ISM frequency energy and if not installed and used properly, that is in strict accordance with the manufacturer's instructions, may cause interference to radio and television reception.

It has been type-tested and found to comply with limits for an ISM Equipment pursuant to part 18 of FCC Rules, which are designed to provide reasonable protection against such interference in a residential installation.

However, there is no guarantee that interference will not occur in a particular installation.

If this equipment does cause interference to radio or television reception, which can be determined by turning the equipment off and on, the user is encouraged to try correct the interference by one or more of the followings:

- Reorient the receiving antenna of radio or television.
- Relocate the Microwave Oven with respect to the receiver.
- Move the microwave oven away from the receiver.
- Plug the microwave oven into a different outlet so that microwave oven and receiver are on different branch circuits.

THE MANUFACTURER is not responsible for any radio or TV interference caused by UNAUTHORIZED MODIFICATION to this microwave oven. It is the responsibility of the user to correct such interference.

GROUNDING INSTRUCTIONS

This appliance must be grounded. In the event of an electrical short circuit, grounding plug reduces the risk of electric shock by providing an escape wire for electric current. This appliance is equipped with a cord having a grounding wire with a grounding plug. The plug must be plugged into an outlet that is properly installed and grounded.

WARNING: Improper use of the grounding can result in a risk of electric shock.

Consult a qualified electrician or serviceman if the grounding instructions are not completely understood, or if doubt exists as to whether the appliance is properly grounded, and either:

(1) If it is necessary to use an extension cord, use only a 3-wire extension cord that has a 3-blade grounding plug, and a 3-slot receptacle that will accept the plug on the appliance. The marked rating of the extension cord shall be equal to or greater than the electrical rating of the appliance, or (2) Do not use an extension cord. If the power supply cord is too short, have a qualified electrician or serviceman install an outlet near the appliance.

INSTALLATION

- 1 Steady, flat location**
This microwave oven should be set on a steady, flat surface.
- 2 Leave space behind and on sides**
All air vents should be kept a clearance. If all vents are covered during operation, the oven may overheat and, eventually, cause oven failure.
- 3 Away from radio and TV sets**
Poor television reception and radio interference may result if the oven is located close to a TV, Radio, or antenna, feeder and so on.
Place the oven as far from them as possible.
- 4 Away from heating appliances and water taps**
Keep the oven away from hot air, steam or splash when choosing a place to position it, or the insulation might be adversely affected and breakdowns occur.
- 5 Power supply**
 - Check your local power source.
This microwave oven requires a current of approximately 15 amperes, 120 Volts, 60Hz grounded outlet.
 - Power supply cord is about 1.0 meters long.
 1. A short power-supply cord is provided to reduce the risks resulting from becoming entangled in or tripping over a longer cord.
 2. Longer cord sets or extension cord are available any may be used if care is exercised in their use.
 3. If a long cord or extension cord is used, (1) the marked electrical rating of the cord set or extension cord should be at least as the electrical rating of the appliance, (2) the extension cord must be a grounding-type 3-wire cord, and (3) the longer cord should be arranged so that it will not drape over the countertop or tabletop where it can be pulled on by children or tripped over accidentally.

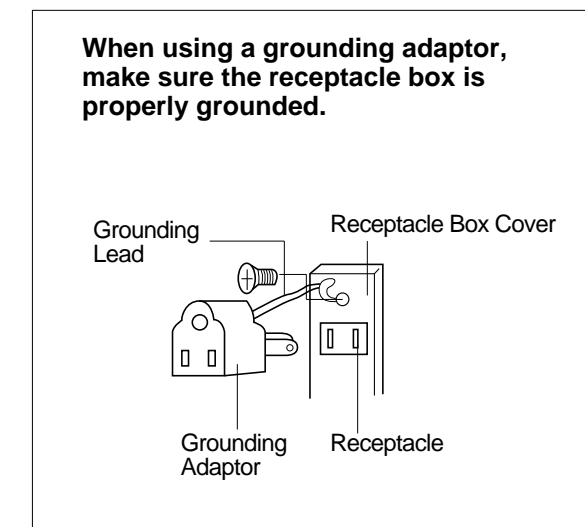
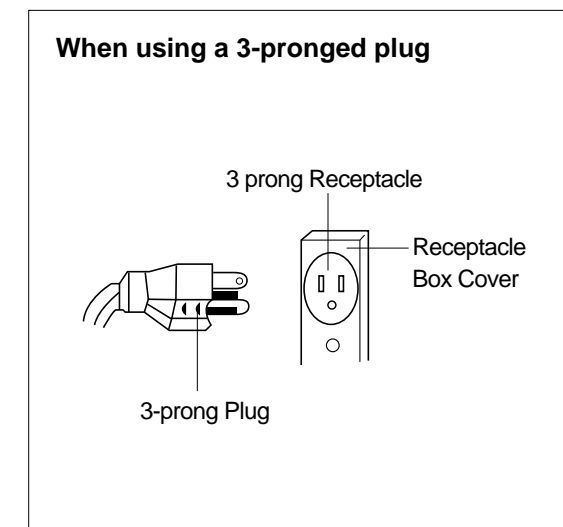

- 6 Examine the oven when unpacking for any damage such as:**
A misaligned door, Broken door, or dent in cavity.
If any of the above are visible, DO NOT INSTALL, and notify dealer immediately.

SPECIFICATIONS

POWER SUPPLY		120V-60Hz, SINGLE PHASE WITH GROUNDING
MICROWAVE	POWER CONSUMPTION	920 W
	OUTPUT POWER	600 W (IEC 705)
	FREQUENCY	2450MHz
OUTSIDE DIMENSIONS (W X H X D)		465 X 274 X 379 mm
CAVITY DIMENSIONS (W X H X D)		290 X 200 X 290 mm
NET WEIGHT		APPROX. 13 Kg
TIMER		60 min.
POWER SELECTIONS		5 LEVELS

* Specifications subject to change without notice.

FEATURES DIAGRAM

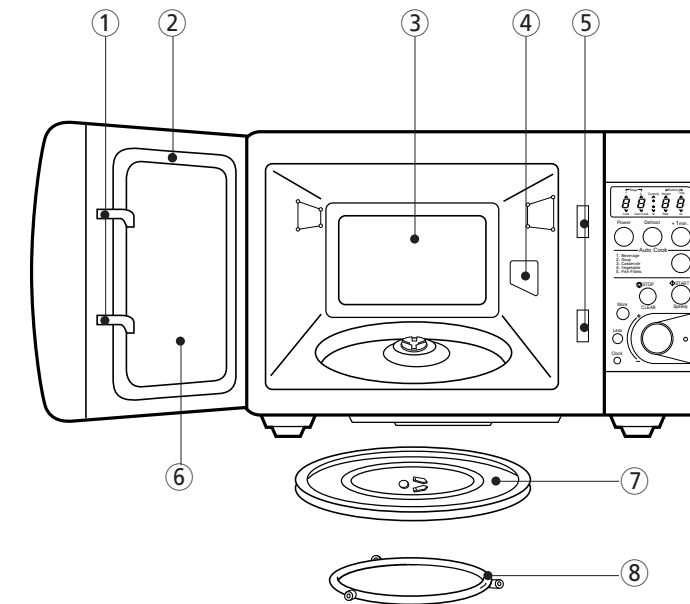

- ① **Door latch** - When the door is closed it will automatically lock shut. If the door is opened while the oven is operating, magnetron will immediately stop operating.
- ② **Door seal** - Door seal maintains the microwave energy within the oven cavity and prevents microwave leakage.
- ③ **Oven cavity.**
- ④ **Spatter shield** - Protects the microwave outlet from splashes of cooking foods.
- ⑤ **Safety interlock system.**
- ⑥ **Door viewing screen** - Allows viewing of food. The screen is designed so that light can pass through, but not the microwaves.
- ⑦ **Glass cooking tray** - Made of special heat resistant glass. Food in a proper receptacle is placed on this tray for cooking.
- ⑧ **Roller guide** - This must always be used for cooking together with the glass cooking tray.

CONTROL PANEL

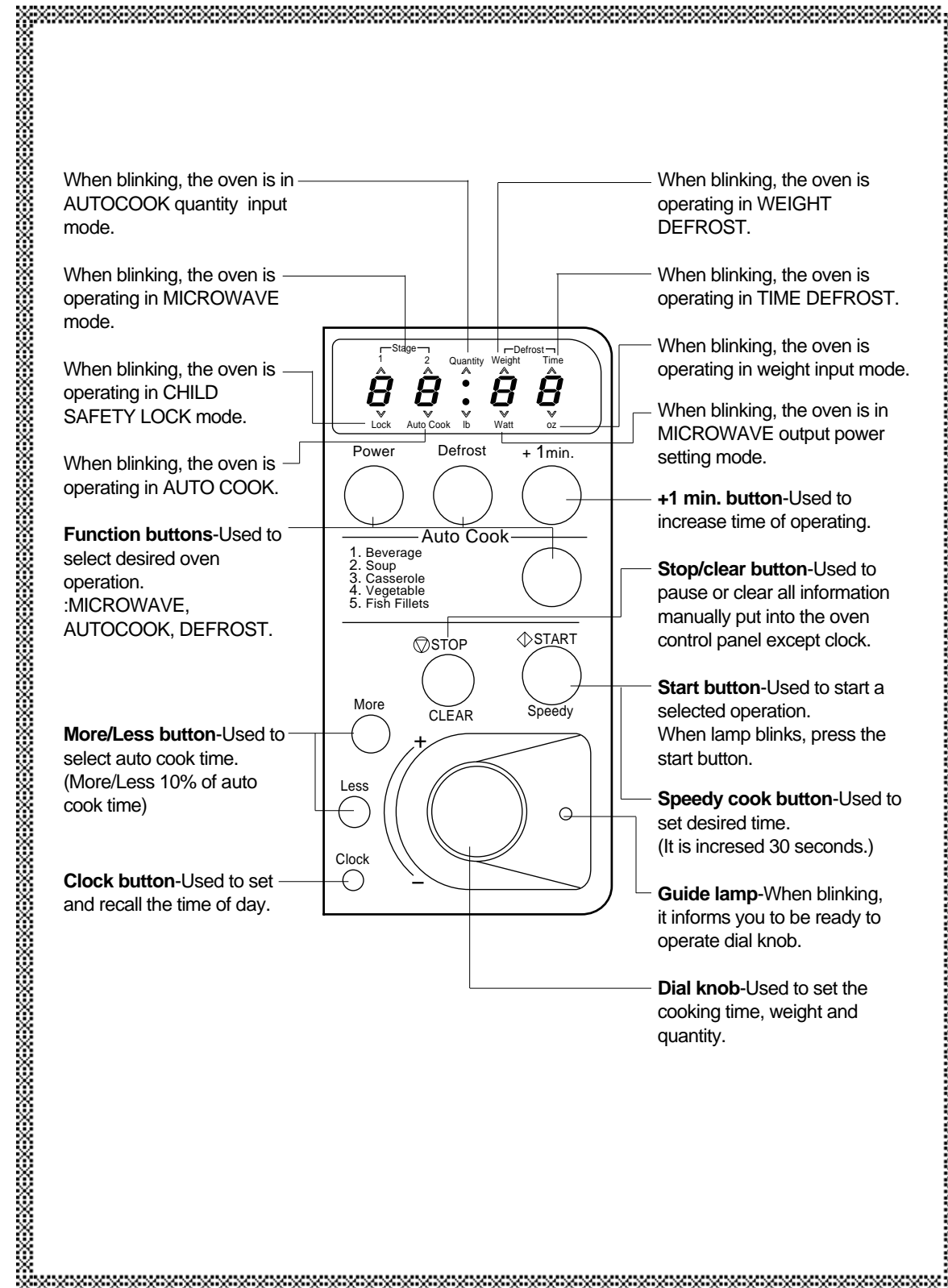

HOW TO SET THE OVEN CONTROLS

- Tips:**
- Be sure to read the cookbook's introduction before operating the oven.
 - Also remember to read this operating instruction for proper safety information and instruction before using the oven.
 - See the cookbook for specific recipes.
 - Prior to setting the controls, place one cup of water in the oven, in a heat-proof glass measuring cup, for testing purposes.
 - When setting the controls, everytime a button is pressed, a beep can be heard.
 - If you don't take off the food after end cooking, buzzer will sound as 1 minute.

CLOCK

- NOTE:**
- When the oven is plugged in, "0:00" appears in the display window.
 - The two dots between the hour and minute are the clock indicator lights. They will start to flash on and off.
 - The time of day will be displayed at all times, except when the oven is operating.
 - In the oven of a power failure or if the oven is unplugged, the clock will have to be reset for the proper time. Once power is restored or oven is plugged in, the display will show "0:00".
 - To reset the time of day, repeat the steps given below.
 - To check the time of day while the oven is operating, press the CLOCK button, then the time will be displayed for 3 seconds.
 - When you turn DIAL KNOB, minutes are increased by to turn right and hours are increased as to turn left.

SETTING THE CONTROL

1. Press CLOCK button. If you push the CLOCK button once again, you can select 12 hour clock system. Then guide lamp will starts blinking.

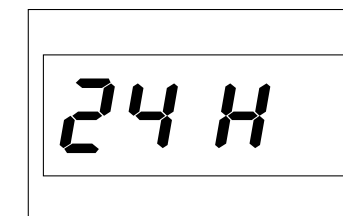

This example is 24 hour clock system.

NOTE: This oven is multiple clock system.

- NOTE:** If you are not setting current time for 3 seconds, display return to old time.

2. Turn left the DIAL KNOB for hour you want.

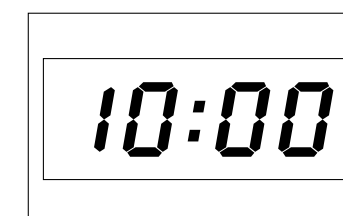

NOTE:

- If you selected 12 hour clock system, this digital clock allows you to set from 1:00 to 12:59.
- If you selected 24 hour clock system, this digital clock allows you to set from 0:00 to 23:59.
- The colon will stop blinking.

3. Turn right the DIAL KNOB for minute you want.

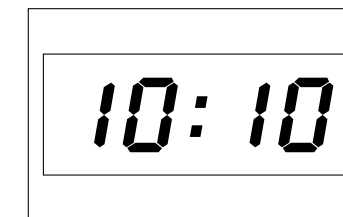

4. Press CLOCK button.

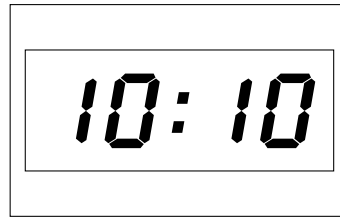

The display will show present time, and the colon starts blinking. This digital clock allows you to set to "10:10"

TIME DEFROST

SETTING THE CONTROL

1. Press DEFROST button twice.

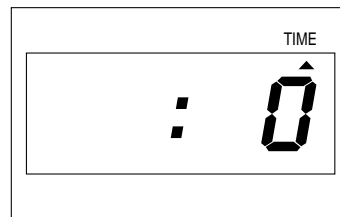

The TIME DEFROST indicator light will light up.

2. Turn the DIAL KNOB for the desired defrosting time.

For example: 20 minutes.

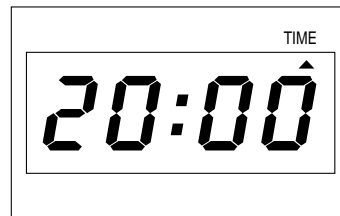

20:00 will show in the display.

NOTE: Time can be set up to 60 minutes.

3. Press \diamond button.

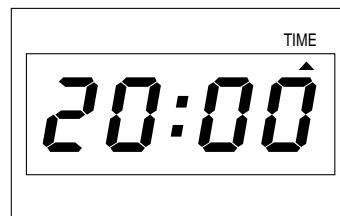

The TIME DEFROST indicator light will start blinking to show the oven is in TIME DEFROST mode.

4. Buzzer will sound at the end of the cooking time. The indicator light will go off. The display panel will return to the time of day. The oven light will turn off and the turntable will stop turning.

NOTE: During the defrosting operation, turn over after buzzer sound for completed defrosting.

WEIGHT DEFROST

NOTE: • This digital weight allows you set from 8 oz to 6 lb 8 oz.
• Whenever you press this button, the display is circulated WEIGHT DEFROST, TIME DEFROST, and MICROWAVE mode.

SETTING THE CONTROL

1. Press DEFROST button once

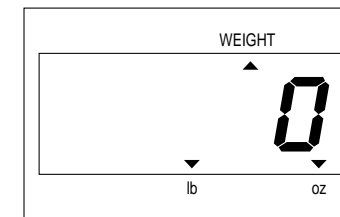

The WEIGHT DEFROST indicator light will come on. The lb, oz indicator light will start blinking.

2. Turn the DIAL KNOB for the desired defrosting weight

For example: 2 lb 4 oz

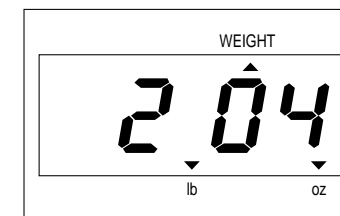

The 204 will show in the display. This display represent 2 lb 4 oz.

3. Press \diamond button

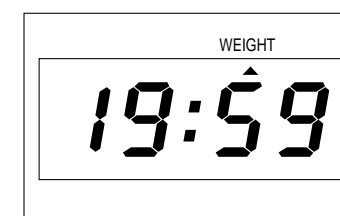

The WEIGHT DEFROST indicator light will start blinking to show the oven is in WEIGHT DEFROST mode.

4. Buzzer will sound at the end of the cooking time. The indicator light will go off. The display panel will return to the time of day. The oven light will turn off and the turntable will stop turning.

NOTE: During the defrosting operation, turn over the food after buzzer sound for completed defrosting.

COOKING IN ONE STAGE

- NOTE:**
- To insure the best microwave and defrost results, be sure to start with a cool oven. Let the oven cool 15~20 minutes with the door slightly open.
 - Power levels are 600W, 500W, 350W, 250W and 100W.
 - It is displayed after an interval of 10 seconds from 10 seconds to 5 minutes, 30 seconds from 5 minutes to 10 minutes, 1 minute from 10 minutes to 60 minutes.

SETTING THE CONTROL

1. Press POWER button
By repeatedly pressing this button, you can also select other power levels.

For example: 600WATT

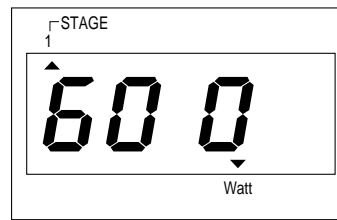

The STAGE1 indicator light will light
The WATT indicator light start blinking.

2. Turn the DIAL KNOB for the desired cooking time.

For example: 10minutes

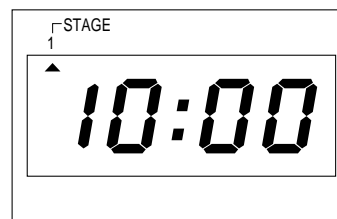

10:00 will show in the display.

NOTE: Time can be set up to 60 minutes.

3. Press ◊ button

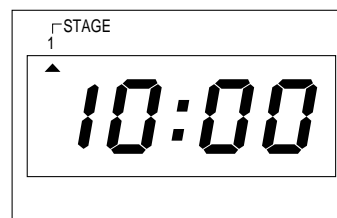

The STAGE1 indicator light will start blinking to show the oven is in the MICROWAVE mode

4. Buzzer will sound at the end of the cooking time. The indicator light will go off. The display panel will return to the time of day. The oven light will turn off and the turntable will stop turning.

COOKING IN TWO STAGES

- NOTE:** For best results, some recipes call for one power level for a certain length of time and another power level for a different length of time.

SETTING THE CONTROL

1. Press POWER button more than three times.
By repeatedly pressing this button, you can also select other power levels.

For example: 250 WATT

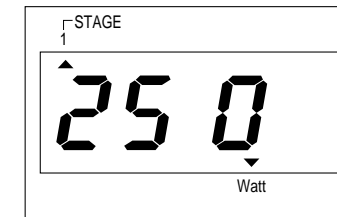

The STAGE1 indicator light will light.
The WATT indicator light start blinking.

2. Turn the DIAL KNOB for the desired cooking time.

For example: 10 minutes

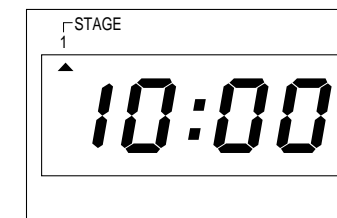

10:00 will show in the display.

NOTE: Time can be set up to 60 minutes.

3. Press POWER button
By repeatedly pressing this button, you can also select other power levels.

For example: 600 WATT

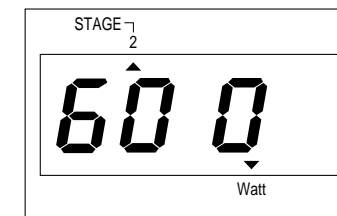

The STAGE2 indicator light will light. The WATT indicator start blinking.

4. Turn the DIAL KNOB for the desired cooking time.

For example: 18minutes

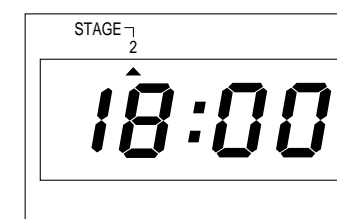

18:00 will show in the display.

NOTE: Time can be set up to 60 minutes.

5. Press \diamond button.

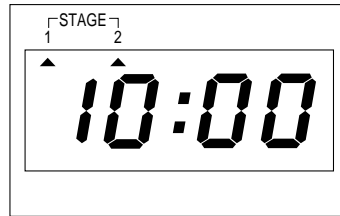

When you touch START, both STAGE1 & 2 indicator lights come on. STAGE1 indicator light blinking to show you that the oven is cooking in the first of two cook stages. The oven will cook at the power you selected for stage 1.

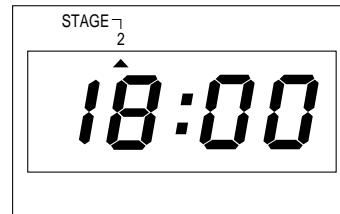

At the end of stage 1, the oven will beep and start the second stage 2. The STAGE1 indicator light will go off and the STAGE2 indicator light starts blinking. The display counts down the time to show you how much cooking time is left in the second stage.

6. Buzzer will sound at the end of the cooking time. The indicator light will go off. The display panel will return to the time of day. The oven light will turn off and the turntable will stop turning.

AUTO COOK

NOTE: • There is programmed for cooking of five kinds (1~5).
• You don't have to worry about setting time, power and function.

SETTING THE CONTROL

You can operate MORE or LESS than programmed time as pressing MORE or LESS button whenever MORE or LESS button, display is changed "10" or "-10".

10: Adds 10% for programmed time.
-10: Remove 10% for programmed time.

1. Press AUTO COOK button



The AUTO COOK indicator light will light "AC-1" will show in the display. The quantity indicator light will start blinking.

2. Select the desired cooking.

For example: SOUP

Press AUTO COOK button twice.



"AC-2" will show in the display. The quantity indicator light will start blinking.

3. If you want to select other menu, press AUTO COOK button until display your desired cooking menu.

4. Turn the DIAL KNOB for desired cooking quantity.

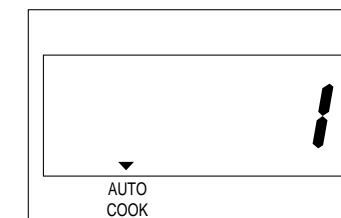

5. Select the desired cooking quantity.

For example: 3(12.3oz)

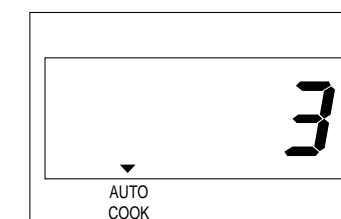

"3" will show in the display.

6. If you want to select other, turn the dial knob until display you desired.

7. Press \diamond button.
This example don't set
MORE or LESS function.

The oven will now start auto cook
for menu 2.
The indicator light starts blinking.

8. Buzzer will sound at the end of the cooking time. The indicator light will go off. The display panel will return to the time of day. the oven light will turn off and the turntable will stop turning.

NOTE: • AUTO COOK menu and quantity.

MENU NO		QUANTITY NO	
1	BEVERAGE	1	1 CUP
		2	2 CUPS
		3	3 CUPS
2	SOUP	1	8.8 oz
		2	10.6 oz
		3	12.3 oz
		4	14.1 oz
3	CASSEROLE	1	7.1 oz
		2	14.1 oz
		3	1 lb 5 oz
		4	1 lb 12 oz
4	VEGETABLE	1	8.8 oz
		2	10.6 oz
		3	12.3 oz
		4	14.1 oz
5	FISH FILLET	1	10.6 oz
		2	14.1 oz
		3	1 lb 2 oz
		4	1 lb 5 oz
		5	1 lb 9 oz

SPEEDY COOK

SETTING THE CONTROL

1. Press \diamond button.
Then start lamp will start
blinking.

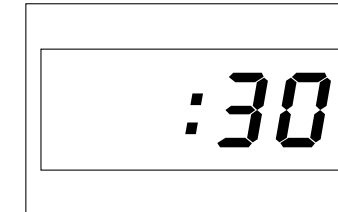

Whenever the button is pressed,
cooking time is increased 30
seconds.
If the time was setting, this oven is
operated automatically after 2
seconds to microwave high power.

NOTE: This key is increased from 30 seconds to 5 minutes.
If you are pressing more than about 0.5 seconds, the time is increased 30 seconds continuously.

CHILD SAFTY LOCK

- The safty lock prevents unwanted oven operation such as by small children.
- To set, press STOP/CLEAR for 3 seconds, lock indicator light starts blinking.
- To cancel, press STOP/CLEAR for 3 seconds, lock indicator goes off.

+1 min.

- The function can use when oven is working state.
- Whenever press this button, time is increased as 1 minute.
- Time is increased until 60 minutes.



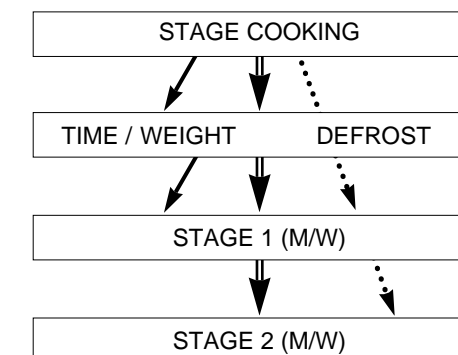

STAGE COMBINATIONS

This oven has the ability to be programmed to do up to three consecutive functions. These combinations are given below and either the complete program or part of it can be used.





- * When you set stage mode, indicator is lighted only setting.
- * When you press START button, all indicators are lighted setted function.
Indicator of operating function is blinking.

TO STOP THE OVEN WHILE IT IS OPERATING

- Press  (STOP/CLEAR) button.
 - Touch  once more to erase all instruction except clock.
 - You can restart the oven by touching  (START) button.
- Open the door
 - You can restart the oven by closing the door and touching  button.

NOTE: Oven stops operating when door is opened.

ERASING INSTRUCTIONS

- Touch  (STOP/CLEAR) button to erase all instructions you set previously.
- Opening the oven door during cooking dose not erase cooking instruction.
- If you push twice  button during operation, the cooking instruction is all erased.

GENERAL COOKING HINTS

- When cook a roast with an excess amount of drippings, it is helpful to remove the drippings at turnover time to prevent spattering.
- Prick the meats, fish or poultry with a fork to prevent bursting. Steam builds up pressure in meats, fish or poultry which are tightly covered by a skin or membrane.
- Reduce suggested cooking times, it is always better to undercook foods rather than to over-cook them. If a range of times is stated in a recipe, cook the minimum suggested time, check for doneness, and then cook slightly longer if necessary.

GENERAL GUIDELINES

Since microwave cooking to some extent is different from traditional cooking, the following general guidelines should be considered whenever you use your microwave oven:

If the food is undercooked

Check if:

- You have selected the correct power level.
- the selected time is sufficient-the times given in the recipes are approximate. They depend on initial temperature, weight and density of the food etc.
- the container is appropriate.

If the food is overcooked, i.e. dried out or burnt

Before you cook again, consider whether:

- the power level was too high.
- the set time was too long-the times in the recipes are approximate. They depend on initial temperature, weight and density of the food etc.

Points to remember when defrosting

- The shape of the package alters the defrosting time. Shallow rectangular packets defrost more quickly than a deep block.
- Separate pieces as they begin to defrost; free-flow slices defrost; free-flow slices defrost more easily.
- Shield areas of food with small pieces of foil if they start to become warm.
- When defrosting, it is better to under thaw the food slightly and allow the process to finish during the standing time.

The amount of food

The more food you want to prepare the longer it takes. A rule of thumb is that double amount of food requires almost double the time. If one potato takes four minutes to cook, approximately seven minutes are required to cook two potatoes.

Starting temperature of food

The lower the temperature of the food which is being put into the microwave oven, the longer time it takes. Food at room temperature will be reheated more quickly than food at refrigerator temperature.

Composition of the food

Food with a lot of fat and sugar will be heated faster than food containing a lot of water. fat and sugar will also reach a higher temperature than water in the cooking process. The more dense the food, the longer it takes to heat. "Very dense" food like meat takes longer time to reheat than lighter, more porous food like sponge cakes.

Size and shape

Smaller pieces of food will cook more quickly than larger pieces and uniform pieces of food cook more evenly than irregularly shaped foods. With unevenly shaped food, the thinner parts will cook faster than the thicker areas. Place the thinner chicken wings and legs to the centre of the dish.

Stirring, turning of foods

Stirring and turning of foods are techniques used in conventional and well as in microwave cooking to distribute the heat quickly to the centre of the dish and avoids over-cooking at the outer edges of the food.

Covering food helps:

- To reduce spattering
- To shorten cooking times
- To retain food moisture

All covering, which will allow microwaves to pass through are suitable-See above "Which utensils can be used in the oven"

Releasing pressure in foods

Several foods are tightly covered by a skin or membrane.

These foods should be picked with a fork or cocktail stick to relieve the pressure and to prevent bursting, as steam builds up within them during cooking. This applies to jacket potatoes, potatoes, chicken livers, sausages, egg yolks and some fruits.

Standing time

Always allow the food to stand for some time after using the oven. standing time after defrosting, cooking/reheating always improves the result since the temperature will then be evenly distributed through out the food.

In a microwave oven foods continue to cook even when the microwave energy is turned off. They are no longer cooking by microwaves, but they are still being cooked by the conduction of the high residual heat to the centre of the food.

The length of standing time depends on the volume and density of the food. Sometimes it can be as short as the time it takes you to remove the food from the oven and take it to the serving table. However, with larger, denser foods, the standing time may be as long as 10minutes. Upon 'standing', the internal temperature of the food will rise by as much as 8°C and the food will finish cooking during this time.

Arranging food

This is done in several ways in microwave

cooking to give more even cooking results.

If you are cooking several items of the

same food such as jacket potatoes, place

them in a ring pattern for uniform cooking.

When cooking foods of uneven shapes or

thickness, place the smaller or thinner area of

the food towards the centre of the dish where it will be heated

last.

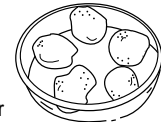

Uneven foods such as fish should be arranged in the oven with the tails to the centre.

If you are saving a meal in the refrigerator

or 'plating' a meal for reheating, arrange

the thicker, denser foods to the outside of

the plate and the thinner or less dense foods

in the middle.

Place thin slices of meat on top of each

other or interlace them.

Thicker slices such as meat loaf

and sausages have to be placed close

to each other.

Gravy or sauce should be reheated in a

separate container.

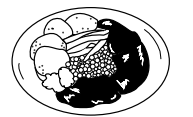

Choose a tall, narrow container rather than a low and wide container. When reheating gravy, sauce or soup, do not fill the container more than 2/3.



When you cook or reheat whole fish, score the skin this prevents cracking.

Shield the tail and head with small pieces

of foil to prevent over-cooking but ensure

the foil does not touch the sides of the

oven.



COOKING UTENSILS

Microwave energy is produced by high frequency radio waves. They are reflected from metal, but will pass through most cooking utensils without heating them. As the waves come into contact with the food, they are converted into heat energy. Listed below are the suggested cooking utensils for this microwave oven and when to use them.

1. Dishes with metal trim of any type - should not be used. This will cause sparking.
2. Glass or ceramic heat proof dishes - excellent for microwave cooking.
3. China dishes and plates - without metal trim may be used to cook and heat individual portions of food.
4. Wood or straw - use only for short period, wood contains some moisture and the microwave energy may cause the wood to dry out and crack.
5. Aluminum foil - may be used in very small pieces for shielding only.
Any aluminum foil used should never be closer than 2.5cm from side walls of oven.
6. Plastic - most heat resistant plastic dinnerware may be used for heating food. However polyethylene, melamine, phenol are unsuitable for use in the oven. They become hot in the microwave.
7. Wax paper - use as a cover to avoid spatters.
8. Metal - In general, metal utensils should not be used in microwave oven.

CARE AND CLEANING

Although your oven is provided with safety features, it is important to observe the following:

1. It is important not to defeat or tamper with safety interlocks.
2. Do not place any object between the oven front face and the door or allow residue to accumulate on sealing surfaces. Wipe the sealing area frequently with a mild detergent, rinse and wipe dry. Never use abrasive powders or pads.
3. When opened, the door must not be subjected to strain, for example, a child hanging on an opened door or any load could cause the oven to fall forward and cause injury and also damaged to the door. Do not operate the oven if it is damaged, until it has been repaired by a trained service technician.
It is particularly important that the oven closes properly and that there is no damage to the:
 - i) Door (bent)
 - ii) Hinges and Hooks (broken or loosened)
 - iii) Door seals and sealing surfaces.
4. The oven should only be adjusted or repaired by anyone except a properly trained service technician.

BEFORE CALLING FOR SERVICE

You can often correct operating problems yourself. If your microwave oven fails to work properly, locate the operating problem in the chart below and try the solutions marked for each problems.

If the microwave oven still does not work properly, contact the nearest Service Center.

Note:

It is quite normal for steam to be emitted around the door during the cooking cycle. The door is not intended to seal the oven cavity completely but its special design contributes to the completion of the appliance.

Caution:

1. Do not attempt to operate the oven while empty as this will cause damage.
2. As an exhaust is located in the rear of the oven, install the oven so as not to block the outlet.

PROBLEM	1	2	3	4	5	6	7	8	9	10	11	12
Oven will not start	X	X	X	X								
Arcing or sparking					X	X						
Unevenly cooked foods					X		X	X	X			
Overcooked foods										X		
Undercooked foods					X				X	X	X	
Improper defrosting					X		X	X		X		X

SOLUTION												
Is start button pressed?	1	2	3	4								
Is power cord plugged in?		2										
Is door closed?					5							
Set the cooking time.						6						
Use approved cookware only.							7					
Do not operate oven empty.								8				
Supplied tray must be used.									9			
Turn of stir food.										10		
Completely defrost food.											11	
Turn correct dial knob/Press correct Function button.												12
Check to see that oven ventilation ports are not restricted.												
Open the door slightly and wait 10~15min. for cooling.												

QUESTIONS AND ANSWERS

Q: I accidentally ran my microwave oven without any food in it. Is it damaged?

A: We do not recommend to operating the microwave oven without any food. However, running the oven empty for a SHORT time will not damage the oven.

Q: Can I open the door when the oven is operating?

A: The door can be opened anytime during the oven operation. Microwave energy will be instantly switched off and the time setting will maintain until the door is closed.

Q: Does microwave energy pass through the viewing screen in the door?

A: No. The metal screen bounces back the energy to the oven cavity. The holes are made to allow light to pass through. They do not let microwave energy pass through.

Q: My microwave oven causes interference with my TV. Is this normal?

A: Some radio and TV interference might occur when you cook with the microwave oven. This interference is similar to the interference caused by small appliances such as mixers, vacuums, blow dryers, etc. It does not indicate a problem with your oven.

Q: How can we know whether the oven is operating or not?

A: Oven is operating only when the door is closed. The operation of fan motor is same as the oven's operating cycle.

Q: The oven only operates when the door is closed.

A: The operation of the fan motor is at the same time as the oven is operating.

Q: Why does my oven light dim?

A: When cooking with DEF. power, the oven must cycle to obtain the selected power levels. The oven light dims and clicking noises can be heard when the oven cycles.

Q: When is the oven light on and off?

A: The oven light is on during the cooking time.

Q: Why does steam accumulate on the oven door?

A: The heat given off from the cooking food warms the air in the oven cavity. This warmed air is carried out of the oven by the air flow pattern in the oven. There are no microwave in the air. The oven vents should never be blocked during cooking.

Q: Why does the smoke come out of the exhaust vent at the back of oven?

A: It is normal for smoke to come out of the vents during cooking. Smoke may be produced when food is overcooked.