

# DAEWOO

## MICROWAVE OVEN OPERATING INSTRUCTIONS

Model No.: **KOR-61AP**

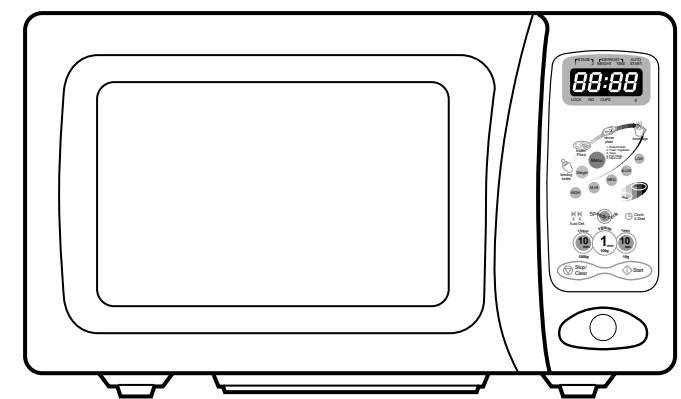

Before operating this oven, please read these instructions completely.

## PRECAUTIONS TO AVOID POSSIBLE EXPOSURE TO EXCESSIVE MICROWAVE ENERGY

- (a) **Do not attempt to operate this oven with the door open** since open-door operation can result in harmful exposure to microwave energy. It is important not to defeat or tamper with the safety interlocks.
- (b) **Do not place any object** between the oven front face and the door or allow soil or cleaner residue to accumulate on sealing surfaces.
- (c) **Do not operate the oven** if it is damaged. It is particularly important that the oven door close properly and that there is no damage to the: (1) door (bent), (2) hinges and latches (broken or loosened), (3) door seals and sealing surfaces.
- (d) **The oven should not be adjusted or repaired** by anyone except properly qualified service personnel.

## TABLE OF CONTENTS

PRECAUTIONS TO AVOID POSSIBLE EXPOSURE TO EXCESSIVE MICROWAVE ENERGY .....	1
TABLE OF CONTENTS .....	1
EARTHING INSTRUCTIONS .....	2
INSTALLATION .....	2
SPECIFICATIONS .....	3
IMPORTANT .....	3
SAFETY INSTRUCTIONS FOR GENERAL USE .....	4
FEATURES DIAGRAM .....	5
OPERATION PROCEDURE .....	6
CONTROLS .....	7
SETTING THE CLOCK .....	7
WEIGHT DEFROSTING .....	8
TIME DEFROSTING .....	9
COOKING IN ONE STAGE .....	10
COOKING IN TWO STAGES .....	11
WEIGHT DEFROSTING AND COOKING IN TWO STAGES .....	12
AUTO START .....	14
TO CHECK AUTO START TIME .....	15
SPEEDY COOK .....	15
ONE TOUCH COOKING .....	15
AUTO COOK (MENU & WEIGHT) .....	17
FEEDING BOTTLE .....	18
MORE, LESS .....	18
CHILD SAFETY LOCK .....	18
TO STOP THE OVEN WHILE THE OVEN IS OPERATING .....	18
COOKING UTENSILS .....	19
CARE AND CLEANING .....	19
BEFORE YOU CALL FOR SERVICE .....	20
QUESTIONS AND ANSWERS .....	20

## EARTHING INSTRUCTIONS

This appliance must be earthed. In the event of an electrical short circuit, earthing reduces the risk of electric shock by providing an escape wire for the electric current. This appliance is equipped with a cord having a earthing wire with a earthing plug. The plug must be plugged into an outlet that is properly installed and earthed.

**WARNING:** Improper use of the earthing plug can result in a risk of electric shock. Consult a qualified electrician or serviceman if the earthing instructions are not completely understood, or if doubt exists as to whether the appliance is properly earthed. If it is necessary to use an extension cord, use only a 3-wire extension cord that has a 3-blade earthing plug, and a 3-slot receptacle that will accept the plug on the appliance. The marked rating of the extension cord should be equal to or greater than the electrical rating of the appliance.

## INSTALLATION

- 1 **Steady, flat location**  
This oven should be set on a steady, flat surface. This oven is designed for counter top use only.
- 2 **Leave space behind and side**  
All air vents should be kept a clearance. If all vents are covered during operation, the oven may overheat and, eventually, oven failure.
- 3 **Away from radio and TV sets**  
Poor television reception and radio interference may result if the oven is located close to a TV, Radio antenna, feeder and so on.  
Position the oven, as far from them as possible.
- 4 **Away from heating appliance and water taps**  
Keep the oven away from hot air, steam or splash when choosing a place to position it, or the insulation might be adversely affected and breakdowns occur.
- 5 **Power supply**
  - Check your local power source. This oven requires a current of approximately 5 amperes, 230V 50Hz.
  - Power supply cord is about 1.1 meters long.
  - The voltage used must be the same as specified on this oven. Using a higher voltage may result in a fire or other accident causing oven damage. Using low voltage will cause slow cooking. We are not responsible for damage resulting from use of this oven with a voltage of ampere fuse other than those specified.
  - This appliance is supplied with cable of special type, which, if damaged, must be repaired with cable of same type.
- 6 **Examine the oven after unpacking for any damage such as:**  
A misaligned door, Broken door, A dent in cavity. If any of the above are visible, DO NOT INSTALL, and notify dealer immediately.
- 7 **Do not operate the oven if it is colder than room temperature.**  
(This may occur during delivery in cold weather.) Allow the oven to become room temperature before operating.

## SPECIFICATIONS

POWER SUPPLY		230V~50Hz, SINGLE PHASE WITH EARTHING
MICROWAVE	POWER CONSUMPTION	1200 W
	OUTPUT POWER	800 W (IEC 705)
	FREQUENCY	2450 MHz
OUTSIDE DIMENSIONS (W X H X D)		465 X 275 X 364 mm
CAVITY DIMENSIONS (W X H X D)		290 X 200 X 290 mm
NET WEIGHT		APPROX. 13.5 Kg
TIMER		59 min. 90 sec.
POWER SELECTIONS		5 LEVELS

\* Specifications subject to change without notice.

## IMPORTANT

The wires in this mains lead are coloured in accordance with the following code.

Green-and-yellow : Earth  
 Blue : Neutral  
 Brown : Live

As the colours of the wires in the mains lead of this appliance may not correspond with the coloured markings identifying the terminals in your plug, proceed as follows:

The wire which is coloured green-and-yellow must be connected to the terminal in the plug which is marked with the letter 'E' or by the earth symbol or green-and-yellow. The wire which is coloured blue must be connected to the terminal which is marked with the letter 'N' or coloured black.

The wire which is coloured brown must be connected to the terminal which is marked with the letter 'L' or coloured red.

**WARNING:** This appliance must be earthed.

## SAFETY INSTRUCTIONS FOR GENERAL USE

Listed below are, as with all appliances, certain rules to follow and safeguards to assure top performance from this oven:

1. Do not use the oven for any reason other than food preparation, such as for drying clothes, paper, or any other nonfood items or for sterilizing purposes.
2. Do not use the oven when empty, this could damage the oven.
3. Do not use the oven cavity for any type of storage, such as papers, cookbook, cookware, etc.
4. Do not operate the oven without the glass tray in place. Be sure it is properly sitting on the rotating base.
5. Make sure you remove caps or lids prior to cooking when you cook food sealed in bottles.
6. Do not put foreign material between the oven surface and door. It could result in excessive leakage of microwave energy.
7. Do not use recycled paper products for cooking. They may contain impurities which could cause sparks and/or fires when used during cooking.
8. Do not pop popcorn unless popped in a microwave approved popcorn popper or unless it's commercially packaged and recommended especially for microwave ovens. Microwave popped corn produces a lower yield than conventional popping; there will be a number of unpopped kernels. Do not use oil unless specified by the manufacturer.
9. Do not cook any food surrounded by a membrane, such as egg yolks, potatoes, chicken livers, etc., without first piercing them several times with a fork.
10. Do not pop popcorn longer than the manufacturer's directions. (popping time is generally below 3 minutes).  
 Longer cooking does not yield more popped corn, it can cause scorchings and fire.  
 Also, the cooking tray can become too hot to handle or may break.
11. Should the microwave oven emit smoke in quantity to indicate a fire, keep the oven door shut, switch the appliance off and disconnect the mains lead from the outlet.
12. When flammable food containers are used in the oven (e.g. packet popcorn) be sure to check the cooking process periodically in case fire has occurred.
13. Always stir and/or shake the containers of baby foods prior to testing their temperature and serving the contents.
14. Always test the temperature of food or drink which has been heated in a microwave oven before you give it to somebody, especially to children or elderly people. This is important because things which have been heated in a microwave oven carry on getting hotter even though the microwave oven cooking has stopped.

## FEATURES DIAGRAM

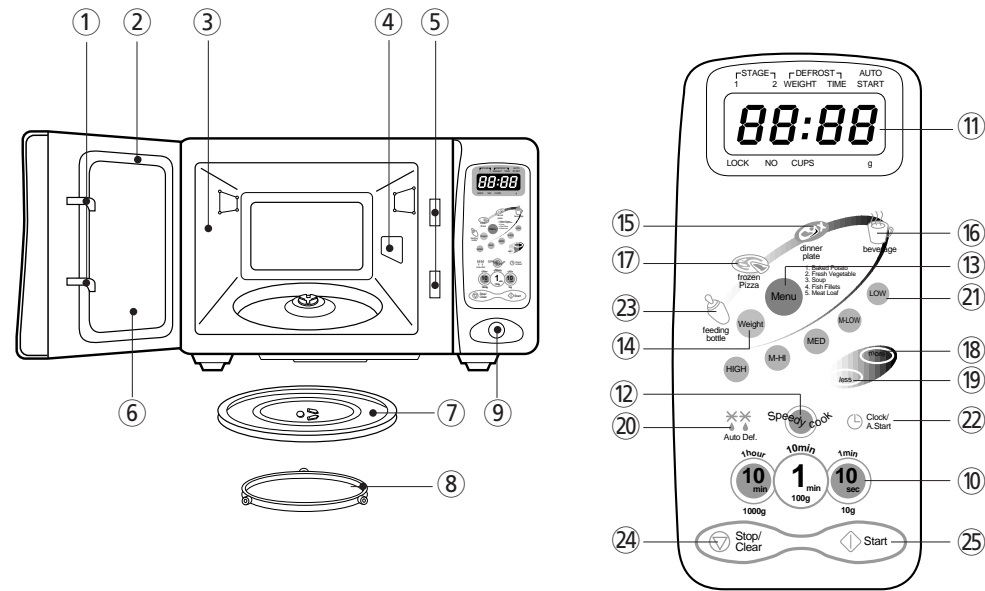

- ① **Door latch**-When the door is closed it will automatically lock shut. If the door is opened while the oven is operating. The magnetron will automatically shut off.
- ② **Door seal**-The door seal maintains the microwaves within the oven cavity and prevents microwave leakage.
- ③ **Oven cavity.**
- ④ **Spatter shield**-Protects the microwave outlet from splashes of cooked foods.
- ⑤ **Safety interlock system**-Prevents the oven from operating while the door is opened.
- ⑥ **Door screen**-Allows viewing of food. The screen is designed so that light can pass through, but not the microwaves.
- ⑦ **Glass cooking tray**-Made of special heat resistant glass. The tray must always be in proper position before operating. Do not cook food directly on the tray.
- ⑧ **Roller guide**-Supports the glass cooking tray.
- ⑨ **Door release button**-Pushing this button stops oven operation and opens the door.
- ⑩ **Time set pad**-Used to set the cooking time and the present time.
- ⑪ **Display**-Cooking time, power level, present time are displayed.
- ⑫ **Speedy cook**-Touch to set any desired reheat setting.
- ⑬ **Menu**-Used to select foods.
- ⑭ **Weight**-Used to select quantity of foods.
- ⑮ **Dinner plate**-Used to reheat dinner plate.
- ⑯ **Beverage**-Used to reheat beverage.
- ⑰ **Frozen pizza**-Used to reheat frozen pizza.
- ⑱ **More**-Used to add on one touch cooking.
- ⑲ **Less**-Used to remove one touch cooking.
- ⑳ **Auto defrost**-Used to defrost foods.
- ㉑ **Power set pad**-Used to set power level.
- ㉒ **Clock/A.start**-Used to set clock & Used to set auto start.
- ㉓ **Feeding bottle**-Used to sterilize bottle.
- ㉔ **Stop/Clear**-Used to stop the oven operation or to delete the cooking data.
- ㉕ **Start**-Used to start a selected operation.

## OPERATION PROCEDURE

This section includes useful information about oven operation.

1. Plug power supply cord into a 230V 50Hz power outlet.
2. After placing the food in a suitable container, open the oven door and put it on the glass tray. The glass tray must always be in place during cooking.
3. Shut the door. Make sure that it is firmly closed.

- 1 When the oven door is opened, the turns off.
- 2 The oven door can be opened at any time during operation by touching the door release button on the control panel. The oven will automatically shut off. To restart the oven, close the door and then touch START.
- 3 Each time a pad is touched, a BEEP will sound to acknowledge the touch.
- 4 The oven automatically cook on full power unless set to a lower power level.
- 5 The display will show " :0" when the oven is plugged in.
- 6 Time clock returns to the present time when the oven turns off.
- 7 When the STOP/CLEAR pad is touched during the oven operation, the oven stops cooking and all information retained. To erase all information (except the present time), touch the STOP/CLEAR pad once more. If the oven door is opened during the oven operation, all information is retained.
- 8 If the START pad is touched and the oven does not operate, check the area between the door and door seal for obstructions and make sure the door is closed securely. The oven will not start cooking until the door is completely closed or the program has been reset.

Make sure the oven is properly installed and plugged into the electrical outlet.

### Wattage output chart

- The power-level is set by pressing the power set pad. The chart shows the display, the power level and the percentage of power.

Touch pad	Power Level (Display)	Approximate Percentage of Power
HIGH	P-HI	100%
M-HI	P-80	80%
MED	P-60	60%
M-LOW	P-40	40%
LOW	P-20	20%

# CONTROLS

## SETTING THE CLOCK

When the oven is first plugged in, the display will flash " :0" and a tone will sound. If the AC power ever goes off, the display will flash " :0" when the power comes back on.

DO THIS...

THIS HAPPENS...

CLOCK/  
A.START

1. Touch **CLOCK/A.START** pad.

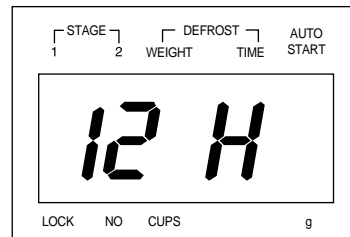

This is a 12 hour clock system.

CLOCK/  
A.START

2. Touch **CLOCK/A.START** pad once more.

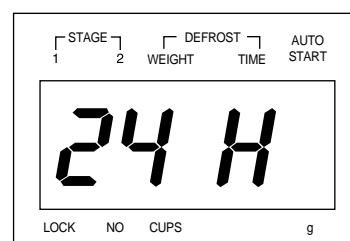

This is a 24 hour clock system.

**NOTE:** This oven is multiple clock system. If you want 12 hour clock system, omitted this step.

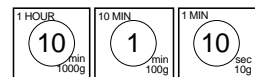

3. Touch the **TIME** set pads to set the correct present time.

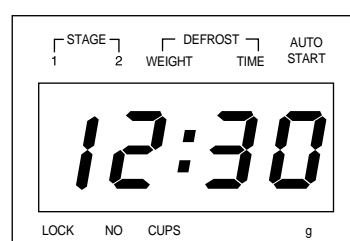

**EXAMPLE:** To set the time to "12:30".

- Touch 1 HOUR 12 times.
  - Touch 10 MIN 3 times.
- The display will then begin blinking.

CLOCK/  
A.START

4. Touch **CLOCK/A.START** pad.

The display stop blinking and the colon starts blinking.  
If you selected 12 hour clock system this digital clock allows you to set from 1:00 to 12:59.  
If you selected 24 hour clock system, this digital clock allows you to set from 0:00 to 23:59.

**NOTE:** If you attempt to enter an incorrect time, the time will not be set and a error signal tone will sound. Touch the **CLOCK/A.START** pad re-enter the time.

## WEIGHT DEFROSTING

WEIGHT DEFROST lets you easily defrost food by eliminating guesswork in determining defrosting time. The minimum weight for WEIGHT DEFROST is 200 grams. The maximum weight for WEIGHT DEFROST is 3000 grams. Follow the steps below for easy defrosting.

DO THIS...

THIS HAPPENS...

AUTO  
DEFROST

1. Touch **AUTO DEFROST** pad.

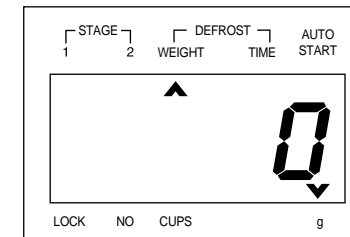

The **WEIGHT DEFROST** indicator lights and "0" is displayed. And the g indicator starts blinking.

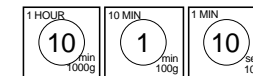

2. Touch the **WEIGHT** set pads for the defrosting weight you want.

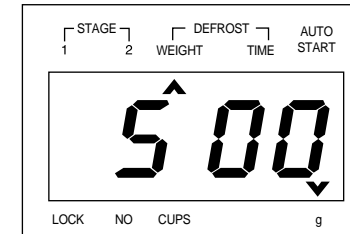

**EXAMPLE:** To set the 500 grams.  
• Touch 100g 5 times.

START

3. Touch **START** pad.

**WEIGHT DEFROSTING** begins. The defrosting time is automatically determined by the food category and weight entered. The g indicator goes off and the **WEIGHT DEFROST** indicator blinks and the defrosting time counts down in the display window. The oven beeps during the defrosting cycle to signal that the food needs to be turned or rearranged. When the defrosting time ends, you will hear 3 beeps.

**NOTE:** To prevent overdefrosting, thin areas or edges can be shielded with strips of aluminum foil.

## TIME DEFROSTING

When TIME DEFROST is selected, the automatic cycle divides the defrosting time into periods of alternating defrost and stand times by cycling on and off.

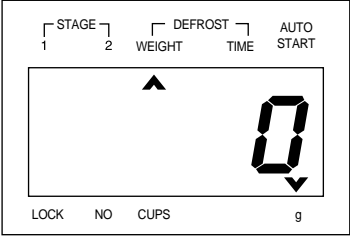
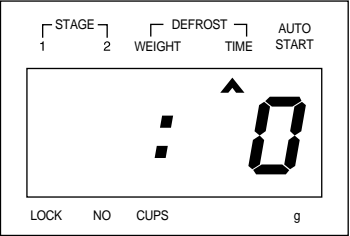
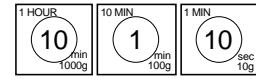
DO THIS...	THIS HAPPENS...
<p><b>AUTO DEFROST</b></p> <p>1. Touch <b>AUTO DEFROST</b> pad.</p>	 <p>The <b>WEIGHT DEFROST</b> indicator lights and "0" is displayed. And the g indicator starts blinking.</p>
<p><b>AUTO DEFROST</b></p> <p>2. Touch <b>AUTO DEFROST</b> pad once more.</p>	 <p>The <b>TIME DEFROST</b> indicator lights and ":0" is displayed.</p>
 <p>3. Touch the <b>TIME</b> set pads for the defrosting time you want.</p>	<p><b>EXAMPLE:</b> To set the time to "27:10".</p> <ul style="list-style-type: none"> <li>• Touch 10 min 2 times.</li> <li>• Touch 1 min 7 times.</li> <li>• Touch 10 sec 1 times.</li> </ul> <p><b>NOTE:</b> Your oven can be programmed for 59 minutes 90 seconds. (59:90)</p>
<p><b>START</b></p> <p>4. Touch <b>START</b> pad.</p>	<p>When you touch <b>START</b> pad, the <b>TIME DEFROST</b> indicator starts blinking to show the oven is in the <b>TIME DEFROST</b> mode. The display counts down the time to show you how much defrosting time is left in the <b>TIME DEFROST</b> mode. The oven beeps during the defrosting cycle to signal that the food needs to be turned or rearranged. When the defrosting time ends, you will hear 3 beeps.</p>

**NOTE:** To prevent overdefrosting, thin areas or edges can be shielded with strips of aluminum foil.



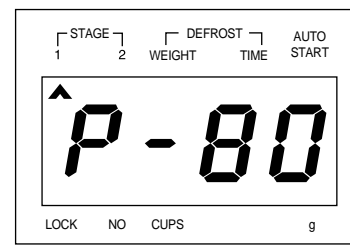
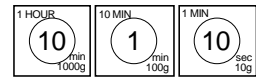
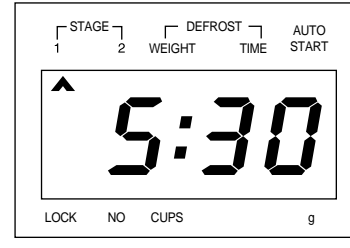

## COOKING IN ONE STAGE

DO THIS...	THIS HAPPENS...
<p><b>M-HI</b></p> <p>1. Touch <b>M-HI</b> pad.</p>	 <p>The <b>STAGE1</b> indicator lights and "P-80" is displayed.</p> <p><b>NOTE:</b> If step 1 is omitted, the oven will cook at full power.</p>
 <p>2. Touch number pads for the cooking time.</p>	 <p><b>EXAMPLE:</b> To set the time to "5:30".</p> <ul style="list-style-type: none"> <li>• Touch 1 min 5 times.</li> <li>• Touch 10 sec 3 times.</li> </ul> <p><b>NOTE:</b> Your oven can be programmed for 59 minutes 90 seconds. (59:90)</p>
<p><b>START</b></p> <p>3. Touch <b>START</b> pad.</p>	<p>When you touch <b>START</b> pad, the <b>STAGE1</b> indicator starts blinking to show the oven is cooking. The display counts down the time to show how much cooking time is left. When the cooking time ends, you will hear 3 beeps.</p>

**NOTE:** Using lower power levels increase the cooking time which is recommended for foods such as cheese, milk and slow cooking of meats.

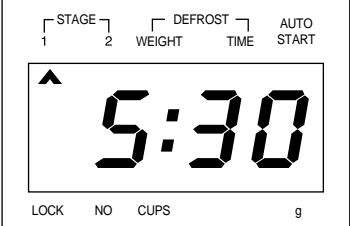

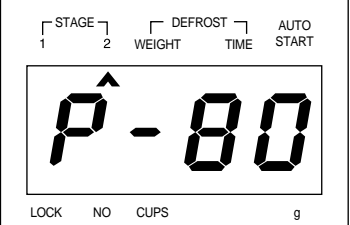
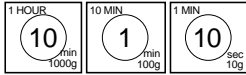
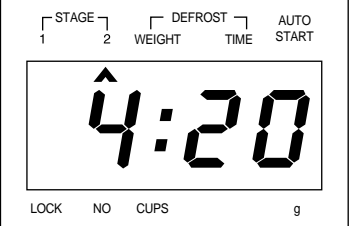



## COOKING IN TWO STAGES

For best results, some recipes call for one Power Level for a certain length of time and another power level for a different length of time. Your microwave oven can be set to change from one to another.

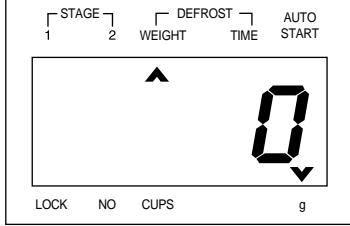
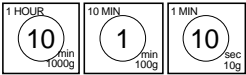
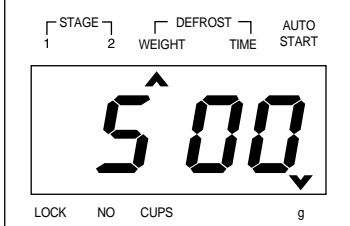
DO THIS...	THIS HAPPENS...
 <p>1. Touch the TIME set pads for the cooking time you want in the first stage.</p>	 <p><b>EXAMPLE:</b> To set the time to "5:30".</p> <ul style="list-style-type: none"> <li>• Touch 1 min 5 times.</li> <li>• Touch 10 sec 3 times.</li> </ul>
 <p>2. Touch <b>M-HI</b> pad.</p>	 <p>The STAGE2 indicator lights and "P-80" is displayed.</p>
 <p>3. Touch the TIME set pads for the cooking time you want in the second stage.</p>	 <p><b>EXAMPLE:</b> To set the time to "4:20".</p> <ul style="list-style-type: none"> <li>• Touch 1 min 4 times.</li> <li>• Touch 10 sec 2 times.</li> </ul>
 <p>4. Touch <b>START</b> pad.</p>	<p>When you touch START pad, both STAGE1 &amp; 2 indicator lights come on, STAGE1 indicator light starts blinking to show you that the oven is cooking in the first of two cook stages. The oven will cook at the power you selected for stage one. At the end of stage one, the oven will beep and start stage two, the STAGE1 indicator goes off and the STAGE2 indicator starts blinking. The display counts down the time remaining in stage two when stage two ends, you will hear 3 beeps.</p>

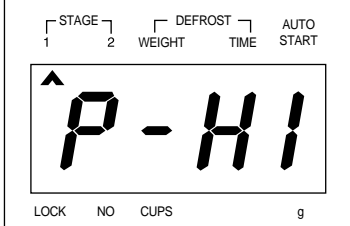
## WEIGHT DEFROSTING AND COOKING IN TWO STAGES

Some recipes require frozen foods to be thawed before cooking. This oven can be programmed to automatically defrost foods before cooking.

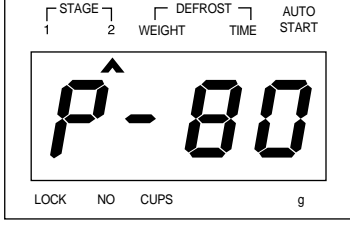
DO THIS...	THIS HAPPENS...
 <p>1. Touch <b>AUTO DEFROST</b> pad.</p>	 <p>The WEIGHT DEFROST indicator lights and "0" is displayed. And the g indicator starts blinking.</p>
 <p>2. Touch the WEIGHT set pads for the defrosting weight you want.</p>	 <p><b>EXAMPLE:</b> To set the 500 grams.</p> <ul style="list-style-type: none"> <li>• Touch 100g 5 times.</li> </ul>
 <p>3. Touch <b>HIGH</b> pad.</p>	 <p>"P-HI" will appear in the displayed. This example shows full power (100%)</p>
 <p>4. Touch the TIME set pads for the cooking time you want in the first stage.</p>	 <p><b>EXAMPLE:</b> To set the time to "5:30".</p> <ul style="list-style-type: none"> <li>• Touch 1 min 5 times.</li> <li>• Touch 10 sec 3 times.</li> </ul>
 <p>5. Touch <b>M-HI</b> pad.</p>	 <p>The STAGE2 indicator lights and "P-80" is displayed.</p>

DO THIS...

THIS HAPPENS...

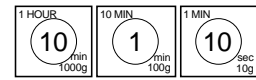

6. Touch the TIME set pads for the cooking time you want in the second stage.

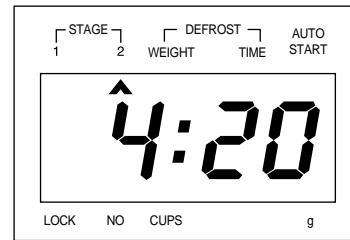

**EXAMPLE:** To set the time to "4:20".

- Touch 1 min 4 times.
- Touch 10 sec 2 times.

START

7. Touch **START** pad.

When you touch START pad, the WEIGHT DEFROST, STAGE1 and STAGE2 indicators come on to confirm the power levels selected. The WEIGHT DEFROST indicator starts blinking to show you that the oven is in WEIGHT DEFROST mode. The display counts down the time remaining in WEIGHT DEFROST mode. Turn over, break a part and redistribute at a beep. At the end of WEIGHT DEFROST mode, the oven will beep and start stage one. The WEIGHT DEFROST indicator goes off and the STAGE 1 indicator starts blinking. The display counts down the time remaining in stage one. At the end of stage one, the oven will beep and start stage two. The STAGE1 indicator goes off and the STAGE2 indicator starts blinking. The display counts down the time remaining in stage two when stage two ends, you will hear 3 beeps.

**AUTO START**

Allows you to program cooking to start at a time you select. The food will automatically start cooking at the desired time. Program is able up to 2 stages (not acceptable DEFROST)

DO THIS...

THIS HAPPENS...

1. Program the desired power level and cooking time.

CLOCK/  
A.START

2. Touch **CLOCK/A.START** pad.

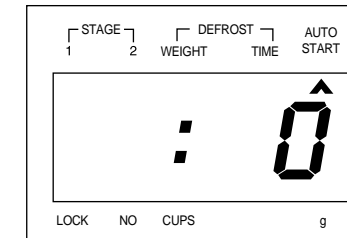

The AUTO START indicator lights and " :0" is displayed.

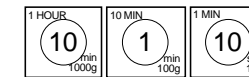

3. Touch the TIME set pads to set the desired start time

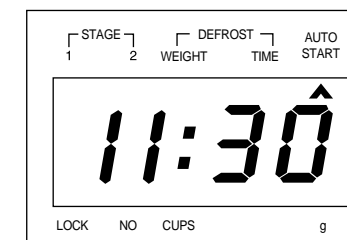

**EXAMPLE:** To set the AUTO START time to "11:30".

- Touch 1 HOUR 11 times.
- Touch 10 MIN 3 times.

START

4. Touch **START** pad.

When you touch START pad, the present time appears in the display and the cooking program indicators come on. The AUTO START indicator and the colon start blinking. When the selected start time arrives the oven begins operating and the oven light turns on. The AUTO START indicator goes off and the next stage indicator begins to blink. When the cooking is completed you will hear 3 beeps. The oven turns off and the present time appears in the display.

**NOTE:** AUTO START can be used for time cooking, if clock is set. If the oven door is opened after programming AUTO START, it is necessary to touch the START pad for the time of day to appear in the readout so that the oven will automatically begin programmed cooking at the chosen AUTO START time. Before setting, check to make sure the clock is showing the correct time of day.

## TO CHECK AUTO START TIME

Once you have correctly programmed the oven for AUTO START, the present time will appear on the display.

DO THIS...

THIS HAPPENS...

CLOCK/  
A.START

The programmed AUTO START time will appear on the display for 3 seconds.

1. Touch **CLOCK/A.START** pad.

## SPEEDY COOK

SPEEDY COOK allows you to reheat for 30 seconds at 100% (full power) by simply touching the SPEEDY COOK pad.

By repeatedly touching the SPEEDY COOK pad, you can also extend reheating time to 5 minutes by 30 seconds.

DO THIS...

THIS HAPPENS...

SPEEDY  
COOK

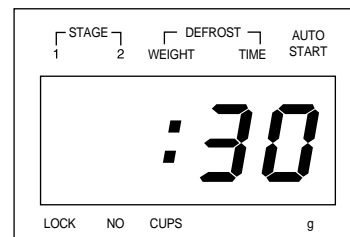

When you touch SPEEDY COOK, ":30" is displayed. After 1.5 seconds, the oven starts reheating.

1. Touch **SPEEDY COOK** pad.

## ONE TOUCH COOKING

One touch cook allows you to cook or reheat many of your favorite foods by touching just one pad. To increase quantity, touch chosen pad until number in display is same as desired quantity to cook. (except for DINNER PLATE)

DO THIS...

THIS HAPPENS...

FROZEN  
PIZZA

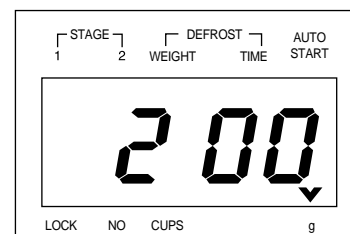

When you touch FROZEN PIZZA "200" is displayed. After 1.5 seconds, the display changed into cooking time of quantity and the oven starts cooking.

1. Touch **FROZEN PIZZA** pad.

### \* FROZEN PIZZA \*

- 200g: Touch FROZEN PIZZA once.
- 300g: Touch FROZEN PIZZA twice within 1.5 seconds.

- NOTE:**
1. Use only one frozen pizza at a time.
  2. Use only frozen pizza for microwave oven.
  3. If the cheese of frozen pizza does not melt sufficiently, cook a few seconds longer.
  4. Some brands of frozen pizza may require more or less cooking time.

DO THIS...

THIS HAPPENS...

BEVERAGE

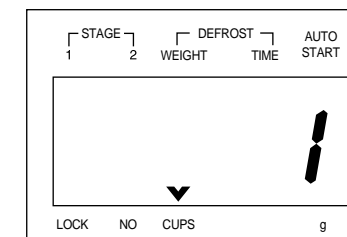

1. Touch **BEVERAGE** pad.

When you touch BEVERAGE pad, "1" is displayed. After 1.5 seconds, the display changed into cooking time of quantity and the oven starts cooking.

### \* BEVERAGE \* (250ml/cup)

- 1 cup (mugs): Touch BEVERAGE once.
- 2 cups (mugs): Touch BEVERAGE twice within 1.5 seconds.
- 3 cups (mugs): Touch BEVERAGE three times within 1.5 seconds.

- NOTE:**
1. This setting is good for restoring cooled beverage to a better drinking temperature.
  2. Stir after cooking.

DO THIS...

THIS HAPPENS...

DINNER  
PLATE

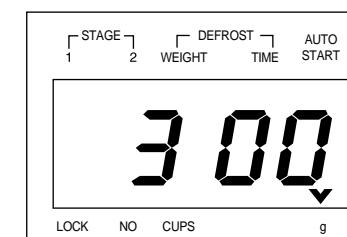

1. Touch **DINNER PLATE** pad.

When you touch DINNER PLATE pad, "300" is displayed. After the 1.5 seconds, the display changed into cooking time of quantity and the oven starts cooking.

- NOTE:** For best results, consult the cookbook.

## AUTO COOK (MENU & WEIGHT)

Auto cook allows you to cook or reheat many of your favorite foods by repeatedly touching menu pad. After the menu selection, touch chosen pad until number in display is same as desired quantity to cook.

DO THIS...

THIS HAPPENS...

MENU

1. Touch **MENU** pad.

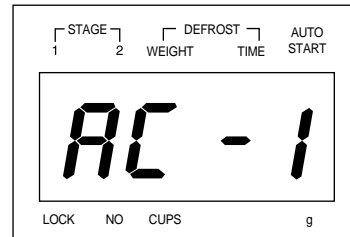

When you touch MENU pad, "AC-1" is displayed. The display will then begin blinking. By repeatedly touching this pad, you can select other food category as shown in the chart below.

CATEGORY	FOOD	TOUCH PAD
AC-1	BAKED POTATO	Touch MENU once.
AC-2	FRESH VEGETABLE	Touch MENU twice.
AC-3	SOUP	Touch MENU three times.
AC-4	FISH FILLETS	Touch MENU four times.
AC-5	MEAT LOAF	Touch MENU five times.

WEIGHT

2. Touch **WEIGHT** pad.

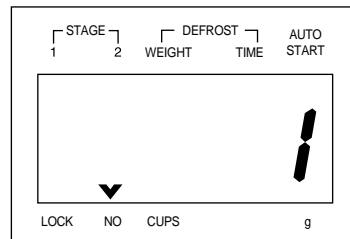

"1" is displayed. After the 1.5 seconds, the display changed into cooking time of quantity and the oven starts cooking.

- \* BAKED POTATO \* (160~180g/ea.)**
  - 1NO (ea.) : Touch WEIGHT once.
  - 2NO (ea.) : Touch WEIGHT twice within 1.5 seconds.
  - 3NO (ea.) : Touch WEIGHT three times within 1.5 seconds.
  - 4NO (ea.) : Touch WEIGHT four times within 1.5 seconds.
- \* FRESH VEGETABLE \***
  - 200g: Touch WEIGHT once.
  - 250g: Touch WEIGHT twice within 1.5 seconds.
  - 300g: Touch WEIGHT three times within 1.5 seconds.
  - 350g: Touch WEIGHT four times within 1.5 seconds.
  - 400g: Touch WEIGHT five times within 1.5 seconds.
- \* SOUP \***
  - 200g: Touch WEIGHT once.
  - 250g: Touch WEIGHT twice within 1.5 seconds.
  - 300g: Touch WEIGHT three times within 1.5 seconds.
  - 350g: Touch WEIGHT four times within 1.5 seconds.
  - 400g: Touch WEIGHT five times within 1.5 seconds.

- \* FISH FILLETS \***
  - 300g: Touch WEIGHT once.
  - 350g: Touch WEIGHT twice within 1.5 seconds.
  - 400g: Touch WEIGHT three times within 1.5 seconds.
  - 450g: Touch WEIGHT four times within 1.5 seconds.
  - 500g: Touch WEIGHT five times within 1.5 seconds.
  - 550g: Touch WEIGHT six times within 1.5 seconds.
  - 600g: Touch WEIGHT seven times within 1.5 seconds.
  - 650g: Touch WEIGHT eight times within 1.5 seconds.
  - 700g: Touch WEIGHT nine times within 1.5 seconds.
- \* MEAT LOAF \***
  - 300g: Touch WEIGHT once.
  - 350g: Touch WEIGHT twice within 1.5 seconds.
  - 400g: Touch WEIGHT three times within 1.5 seconds.
  - 450g: Touch WEIGHT four times within 1.5 seconds.
  - 500g: Touch WEIGHT five times within 1.5 seconds.
  - 550g: Touch WEIGHT six times within 1.5 seconds.
  - 600g: Touch WEIGHT seven times within 1.5 seconds.
  - 650g: Touch WEIGHT eight times within 1.5 seconds.
  - 700g: Touch WEIGHT nine times within 1.5 seconds.

## FEEDING BOTTLE

This is the key of sterilizing feeding bottle function.

At first, detach the nipple from the bottle and pour the 50cc water into each bottle, arrange the bottle symmetrically on the glass tray and operate.

DO THIS...

THIS HAPPENS...

FEEDING BOTTLE

1. Touch **FEEDING BOTTLE** pad.

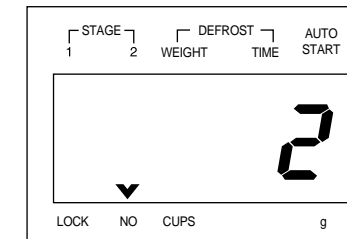

When you press the FEEDING BOTTLE button, "2". After 1.5 seconds, the display changed into sterilizing time of quantity and the oven starts sterilizing.

### \* FEEDING BOTTLE \*

- 2 NO (ea): Touch FEEDING BOTTLE once.
- 4 NO (ea): Touch FEEDING BOTTLE twice within 1.5 seconds.
- 6 NO (ea): Touch FEEDING BOTTLE three times within 1.5 seconds.

## MORE, LESS

MORE pad: adds 10 seconds to 20 seconds.

LESS pad: removes 10 seconds to 20 seconds.

These pads only work in one touch cooking and feeding bottle mode. And always input first.

## CHILD SAFETY LOCK

The safety lock prevents unwanted oven operation such as by small children.

To set, Press STOP/CLEAR for 3 seconds, LOCK indicator lights.

To cancel, press STOP/CLEAR for 3 seconds, LOCK indicator goes off.

## TO STOP THE OVEN WHILE THE OVEN IS OPERATING

1. Press STOP/CLEAR pad.
  - You can restart the oven by touching START pad.
  - Touch STOP/CLEAR once more to erase all instructions.
  - You must enter in new instructions.
2. Open the door.
  - You can restart the oven by closing the door and touching START.

**NOTE:** Oven stops operating when door is opened.

## COOKING UTENSILS

Microwave energy is produced by high frequency radio waves. They are reflected from metal, but will pass through most cooking utensils without heating them.

As the waves come into contact with the food, they are converted into heat energy. Listed below are the suggested cooking utensils for this microwave oven and when to use them.

1. Dishes with metal trim of any type - should not be used. This will cause sparking.
2. Glass or ceramic heat proof dishes - excellent for microwave cooking.
3. China dishes and plates - without metal trim may be used to cook and heat individual portions of food.
4. Wood or straw - use only for short period, wood contains some moisture and the microwave energy may cause the wood to dry out and crack.
5. Aluminum foil - may be used in very small pieces for shielding only.  
Any aluminum foil used should never be closer than 2.5 cm from side walls of oven.
6. Plastic - most heat resistant plastic dinnerware may be used for heating food. However polyethylene, melamine, phenol are unsuitable for use in the oven. They become hot in the microwave.
7. Wax paper - use as a cover to avoid spatters.
8. Metal - In general, metal utensils should not be used in microwave oven.

## CARE AND CLEANING

Although your oven is provided with safety features, it is important to observe the following:

1. It is important not to defeat or tamper with safety interlocks.
2. Do not place any object between the oven front face and the door or allow residue to accumulate on sealing surfaces. Wipe the sealing area frequently with a mild detergent, rinse and wipe dry. Never use abrasive powders or pads.
3. When opened, the door must not be subjected to strain, for example, a child hanging on an opened door or any load could cause the oven to fall forward to cause injury and also damage to the door. Do not operate the oven if it is damaged, until it has been repaired by a trained service technician. It is particularly important that the oven closes properly and that there is no damage to the:
  - i) Door (bent)
  - ii) Hinges and Hooks (broken or loosened)
  - iii) Door seals and sealing surfaces.
4. The oven should not be adjusted or repaired by anyone except a properly trained service technician

## BEFORE YOU CALL FOR SERVICE

Refer to following checklist, you may prevent an unnecessary service call.

**\* The oven doesn't work;**

1. Check that the power cord is securely plugged in.
2. Check that the door is firmly closed.
3. Check that the cooking time is set.
4. Check for a blown circuit fuse or tripped main circuit breaker in your house.

**\* Sparking in the cavity;**

1. Check that utensils are metal containers or dishes with metal trim.
2. Check that metal skewers touch the interior walls.

If there is still a problem, contact the service station.

## QUESTIONS AND ANSWERS

**\* Q :** I accidentally ran my microwave oven without any food in it. Is it damaged?

**A :** Running the oven empty for a short time will not damage the oven. However, it is not recommended.

**\* Q :** Can the oven be used with the glass tray or roller guide removed?

**A :** No. Both the glass tray and roller guide must always be used in the oven before cooking.

**\* Q :** Can I open the door when the oven is operating?

**A :** The door can be opened anytime during the cooking operation. The microwave energy will be instantly switched off and the time setting will maintain until the door is closed.

**\* Q :** Why do I have moisture in my microwave oven after cooking?

**A :** The moisture on the side of your microwave oven is normal. It is caused by steam from cooking food hitting the cool oven surface.

**\* Q :** Does microwave energy pass through the viewing screen in the door?

**A :** No. The metal screen bounces back the energy to the oven cavity. The holes are made to allow light to pass through. They do not let microwave energy pass through.